

Procedures to file a request to the Danish Patent and Trademark Office for use of the Patent Prosecution Highway Pilot Program between the Danish Patent and Trademark Office (DKPTO) and the State Intellectual Property Office of the P.R.C. (SIPO)

Patent Prosecution Highway (PPH) Pilot Program

[0001] The PPH is established to enable an applicant whose claims are determined to be allowable/patentable in the Office of First Filing (OFF) to have the corresponding application filed in the Office of Second Filing (OSF) enter into an accelerated examination procedure.

This PPH will commence on 1. January 2013, for a period of one year ending on 31. December 2013. The trial period may be extended if necessary until SIPO and the DKPTO receive a sufficient number of PPH requests to adequately assess the feasibility of the PPH program. The Offices may also terminate the PPH pilot program if the volume of participation exceeds a manageable level, or for any other reason. A notice will be published if the PPH pilot program is terminated.

A request for PPH is free of charge at the DKPTO.

Requests to the DKPTO

[0002] An applicant should file a request for accelerated examination under the Patent Prosecution Highway (PPH) to the DKPTO by submitting a letter requesting accelerated examination under the PPH accompanied by the relevant supporting documents including a completed PPH request form. The requirements for an application to the DKPTO for accelerated examination under the PPH are given in the following section (paragraph [0003]). Relevant supporting documentation is discussed in a later section (paragraphs [0004]-[0006]) as is the general DKPTO application procedure envisaged at this time (paragraph [0007]).

Requirements for requesting accelerated examination under the PPH Pilot Program at the DKPTO

[0003] There are four requirements for requesting accelerated examination under the PPH pilot program at the DKPTO. These are:

- a) *The DKPTO application is either:*
- (i) a nationally filed application which validly claims priority under the Paris Convention to the SIPO application(s) (*see examples A to C in Annex I*); or
 - (ii) a nationally filed application which validly claims priority under the Paris Convention from a PCT application(s) which has no priority claims (*see example D in Annex I*); or

- (iii) a PCT national phase application where the PCT international application has validly claimed priority from a SIPO national application(s) (*see example E in Annex I*); or
- (iv) a PCT national phase application where the PCT international application has no priority claims (*see example F in Annex I*); or
- (v) a PCT national phase application where the PCT international application has validly claimed priority from a PCT international application(s) which has no priority claims (*see examples G to H in Annex I*); or
- (vi) a divisional of an application referred to any of (i) to (v) (*see example I in Annex I*).

Note that where the relationship between the SIPO application that contains the allowable claims and the DKPTO application is not clearly apparent, the applicant must explain the relationship between these applications (e.g. SIPO application X that contains the allowable/patentable claims, claims domestic priority to SIPO application Y, which is the priority application claimed in the DKPTO application).

b) *At least one corresponding SIPO application has one or more claims that have been determined to be allowable by the SIPO.*

Claims clearly identified to be allowable in the latest Office Action by a SIPO examiner or in the SIPO Granted Patent can form the basis for a request for an accelerated examination under the PPH pilot program at DKPTO.

The Office Action includes:

- (a) Decision to Grant a Patent
- (b) First/Second/Third/...Office Action,
- (c) Decision of Refusal,
- (d) Reexamination Decision, and
- (e) Invalidation Decision.

Claims are also “determined to be allowable/patentable” in the following circumstances: If the SIPO office action does not explicitly state that a particular claim is allowable/patentable, the applicant must include explanation accompanying the request for participation in the PPH pilot program that no rejection has been made in the SIPO office action regarding that claim, and therefore, the claim is deemed to be allowable/patentable by the SIPO.

For example, if claims are not shown in the item of “6. the Opinion on the Conclusion of Examination (审查的结论性意见) about Claims (关于权利要求书)” in the “First Notice of the Opinion on Examination(第一次审查意见通知书)” or “5. the Opinion on the Conclusion of Examination (审查的结论性意见) about Claims (关于权利要求书)” in the “Second/Third/...Notice of the Opinion on Examination(第 次审查意见通知书)” of the SIPO, those claims may be deemed to be implicitly identified to be allowable/patentable and then the applicant must include the above explanation.

c) *All claims in the DKPTO application for accelerated examination under the PPH must sufficiently correspond to one or more of those claims indicated as allowable in the SIPO.*

All claims on file as originally filed or as amended, for examination under the PPH must sufficiently correspond to one or more of those claims indicated as allowable in the SIPO.

Claims are considered to "sufficiently correspond" where, accounting for differences due to translations and claim format, the claims in the DKPTO are of the same or similar scope as the claims in the SIPO, or the claims in the DKPTO are narrower in scope than the claims in the SIPO.

In this regard, a claim that is narrower in scope occurs when a SIPO claim is amended to be further limited by an additional feature that is supported in the specification (description and/or claims).

A claim in the DKPTO which introduces a new/different category of claims to those claims indicated as allowable in the SIPO is not considered to sufficiently correspond. For example, the SIPO claims only contain claims to a process of manufacturing a product, then the claims in the DKPTO are not considered to sufficiently correspond if the DKPTO claims introduce product claims that are dependent on the corresponding process claims.

It is not necessary to include all claims determined to be patentable in the SIPO in the application to the DKPTO, as the deletion of claims is allowable. In a case where an application to the SIPO contains 5 claims which are determined to be allowable, the corresponding application to the DKPTO may contain only 3 of those 5 claims.

Examples of claims which comply with requirement c) are given in Annex III.

d) *The DKPTO has not yet issued a communication stating an intention to grant.*

The heading for such a communication will either be

- "Berigtigelse" (in Danish) or "Intention to Grant" (in English), or
- "Godkendelse" (in Danish) or "Grant" (in English).

Required documents for accelerated examination under the PPH pilot program at the DKPTO

[0003] The following documentation will be needed to support a request for accelerated examination under the PPH pilot program at the DKPTO:

a) *A copy of the office action(s) relating to the corresponding SIPO application(s) and a translation thereof if the office actions are not issued in English.*

The term "office actions" is here used to define the correspondence sent to the applicant or the applicant's representative by the SIPO examiner.

The applicant must supply the DKPTO with copies of the office actions issued by SIPO for the corresponding application(s). If SIPO's office actions are not issued in English, the applicant must also submit translations of SIPO's office actions in either English or Danish. Machine translation is admissible. However, if the DKPTO examiner is not able to understand the translated office actions to a sufficient extent, the DKPTO examiner can request the applicant to submit professional translations.

b) *A copy of the claims determined to be patentable by the SIPO and translations hereof.*

The applicant must submit copies to the DKPTO of the claims allowed by the SIPO. If the allowed claims are not in English, the applicant must further submit a translation of the allowed claims into either English or Danish. Machine translation is admissible. However, if the DKPTO examiner is not able to understand the translated claims to a sufficient extent, the DKPTO examiner can request the applicant to submit professional translations.

c) *A completed claim correspondence table showing the relationship between the claims of the DKPTO application for accelerated examination under the PPH and the claims of the corresponding application considered patentable by the SIPO.*

Sufficient correspondence of claims occurs where the claims satisfy the requirements of section [0003]c. The claim correspondence table must indicate how all the claims in the DKPTO application correspond to the patentable claims in the SIPO application as shown in the Annex IV. The claim correspondence table must be written in either English or Danish.

Where the claims filed to the DKPTO are literal translations of the claims which the SIPO has determined to be allowable, it will be sufficient to write “they are the same” in the claim correspondence table. When the claims applied for at the DKPTO are not literal translations, it will be necessary to explain why there is sufficient correspondence of each claim based on the criteria set out in section [0003]c above.

Applicant is required to submit a new claims correspondence table along with the amendments. Any claims amended or added after the grant of the request for participation in the PPH pilot program but before the DKPTO first action must sufficiently correspond to the claims indicated as patentable/allowable in the in the SIPO application. Any claims amended or added after the first DKPTO action need not to sufficiently correspond to the claims indicated as patentable/allowable in the SIPO in order to overcome the reasons for refusal raised by DKPTOI examiners.

d) *A copy of the references cited by the SIPO examiner.*

If the references are patent documents, it will not be necessary to submit these documents, as they will usually be available to the DKPTO. If the DKPTO does not have access to the relevant patent documents, the applicant must submit these documents at the request of the DKPTO. Non-patent literature must always be submitted.

Submission of translations of the references is not required. However, applicants will be free to file translations as part of the supporting documentation when initially requesting accelerated examination under the PPH to allow prompt consideration of the citations if they so desire.

[0005] The applicant is required to complete a form for requesting accelerated examination under the PPH pilot program (as given in Annex II below) which will be available for download from the DKPTO’s website on <http://internationalcooperation.dkpto.org/patent-prosecution-highways/pph-between-denmark->

[and-china.aspx](#). The form must be sent to the DKPTO along with the relevant supporting documentation.

[0006] The applicant need not provide further copies of documentation, if the applicant has already submitted the documents noted above to the DKPTO through simultaneous or past procedures.

Procedure for accelerated examination under the PPH Pilot Program at the DKPTO

[0007] The applicant files a letter requesting accelerated examination under the PPH Pilot Program to the DKPTO, including the relevant supporting documents as noted above and a completed request form (as given in Annex II below and also available from DKPTO's website). The application for accelerated examination under the PPH may be made by e-mail or conventional mail.

E-mail requests for PPH processing at the DKPTO must be sent to: pvs@dkpto.dk.

PPH requests sent by conventional mail must be sent to:

Danish Patent and Trademark Office
Helgeshøj Allé 81
2630 Taastrup
Denmark

The PPH request form should be the uppermost document when applying for accelerated examination by conventional mail to ensure that the request is processed correctly. All subsequent correspondence from the applicant to the DKPTO must be clearly identified as concerning a PPH pilot program application to ensure that the correspondence is processed correctly.

The DKPTO decides whether the application can be entitled the status of accelerated examination under the PPH when DKPTO receives a request with the documents stated above. When DKPTO decides that a request is acceptable, the application is assigned a special status for accelerated examination. The applicant will not be notified if the request is accepted.

If the request does not meet all the requirements set forth above, the applicant will be notified and the defects in the request will be identified. When the request is corrected by the applicant, the application will continue its accelerated examination under the PPH.

The PPH administrator will consider the request and if all requirements are met the PPH administrator will notify the relevant examining group. The DKPTO's patent examiners will conduct the accelerated examinations.

ANNEX I

Examples of Danish patent applications eligible for accelerated examination under the PPH pilot program at DKPTO:

a)(i) A nationally filed application which validly claims priority under the Paris Convention to the SIPO application(s):

Example A:

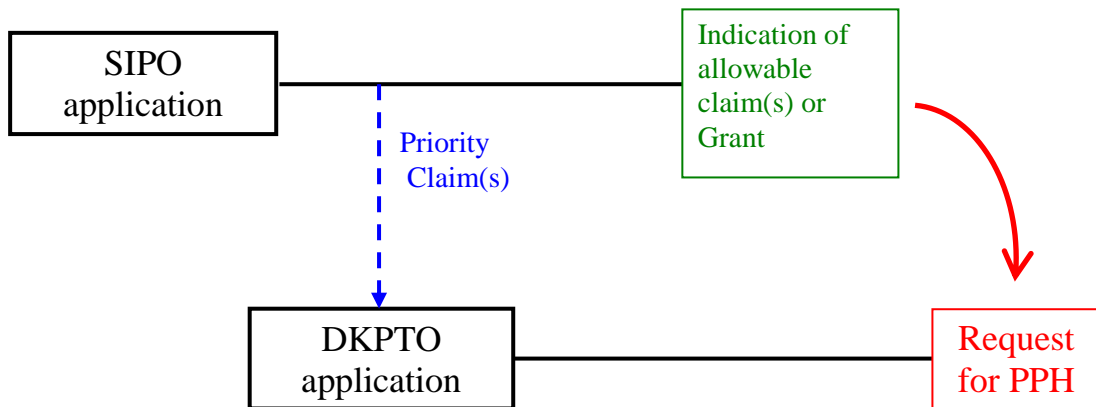

Example B:

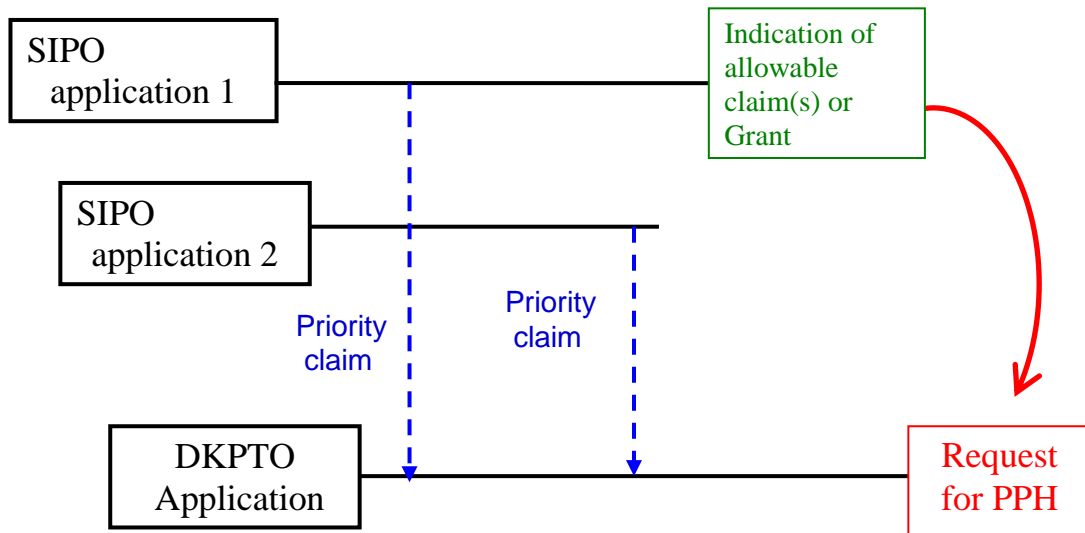

Example C:

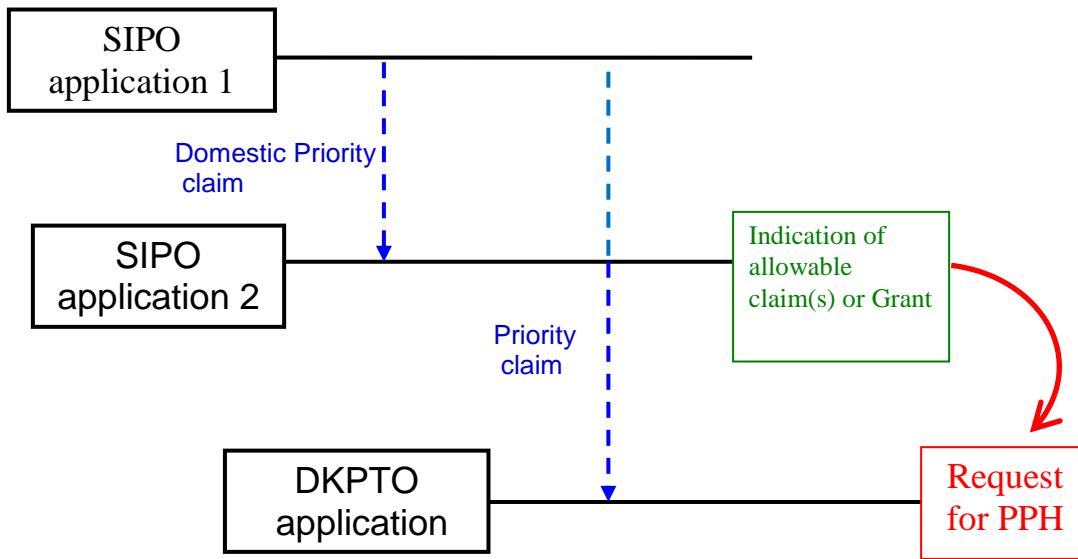

a)(ii) A nationally filed application which validly claims priority under the Paris Convention from a PCT application(s) which has no priority claims:

Example D:

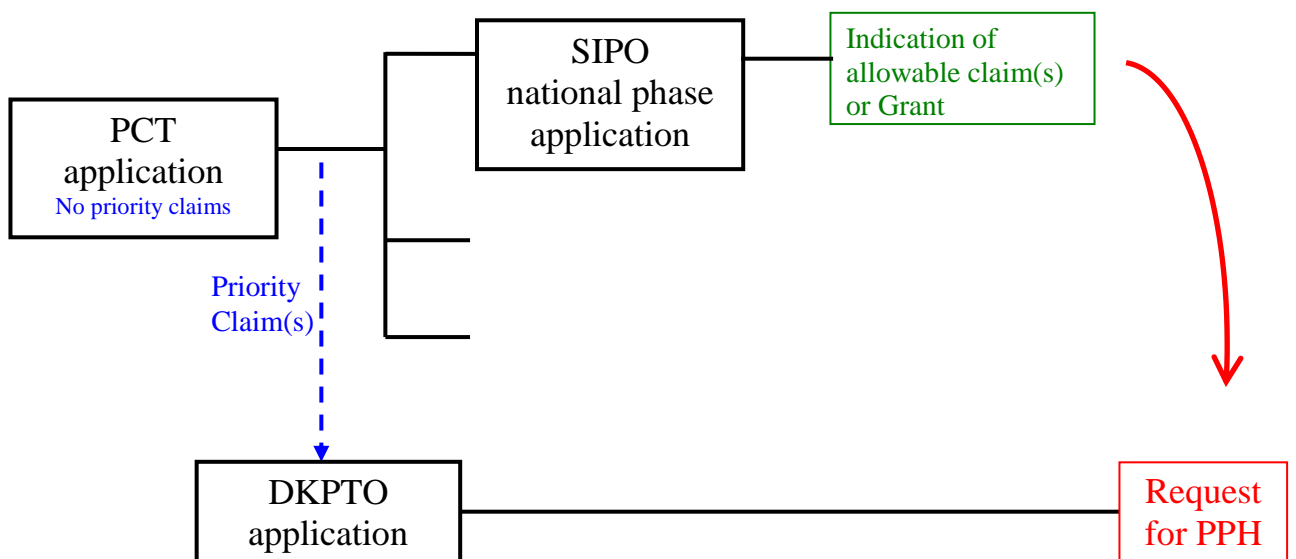

a)(iii) A PCT national phase application where the PCT international application has validly claimed priority from a SIPO national application(s):

Example E:

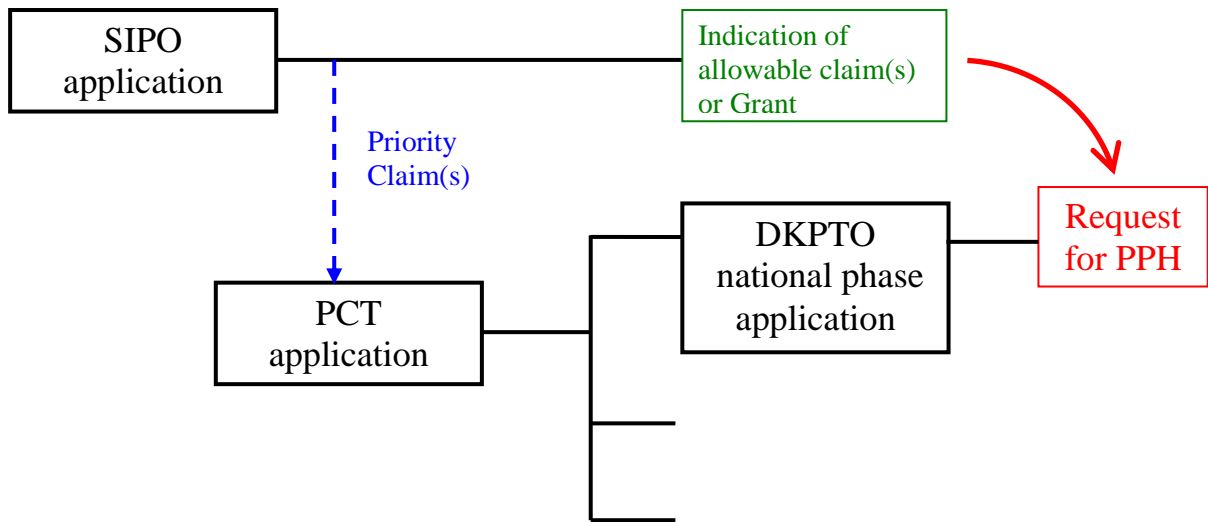

a)(iv) A PCT national phase application where the PCT international application has no priority claims:

Example F:

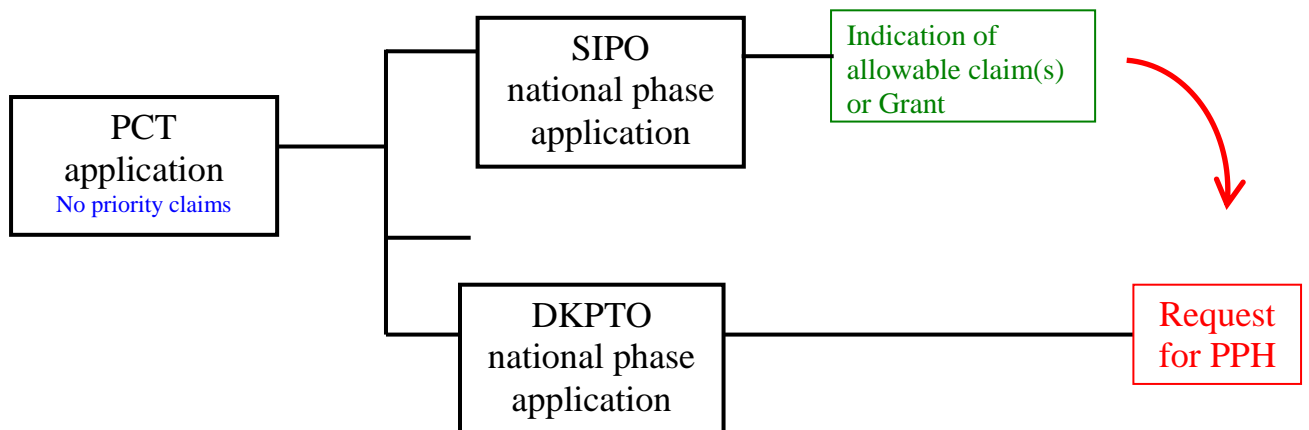

a)(v) A PCT national phase application where the PCT international application has validly claimed priority from a PCT application(s) which has no priority claims:

Example G:

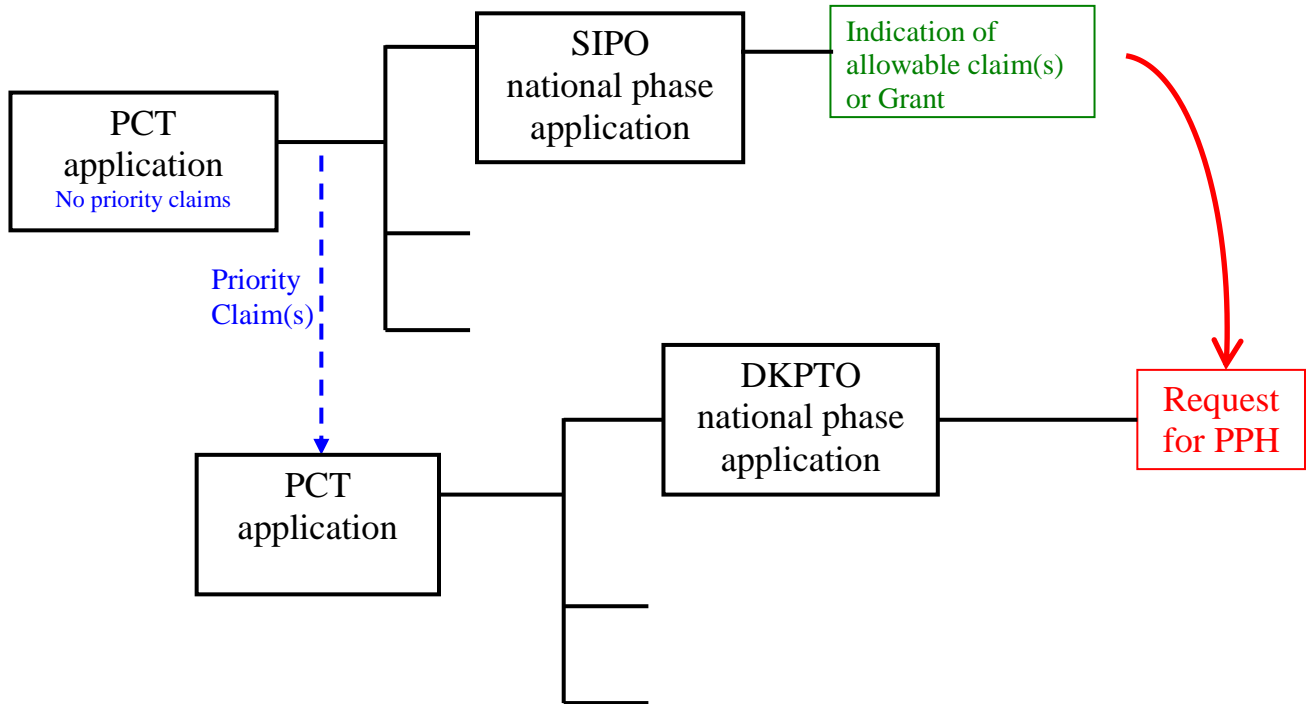

Example H:

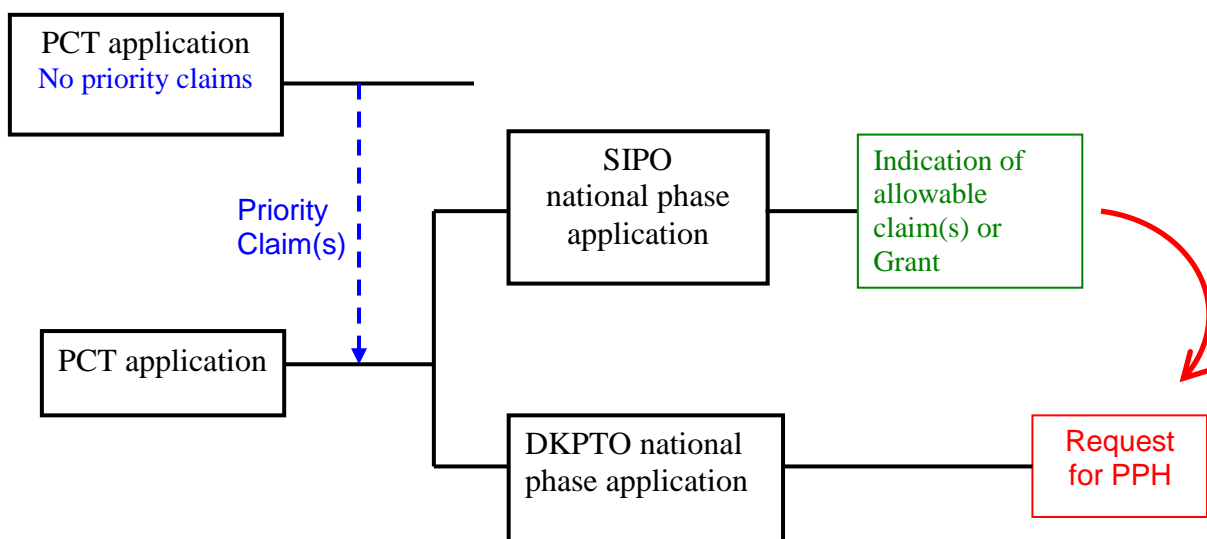

a)(vi) A divisional of an application referred to any of (i) to (v):

Example I:

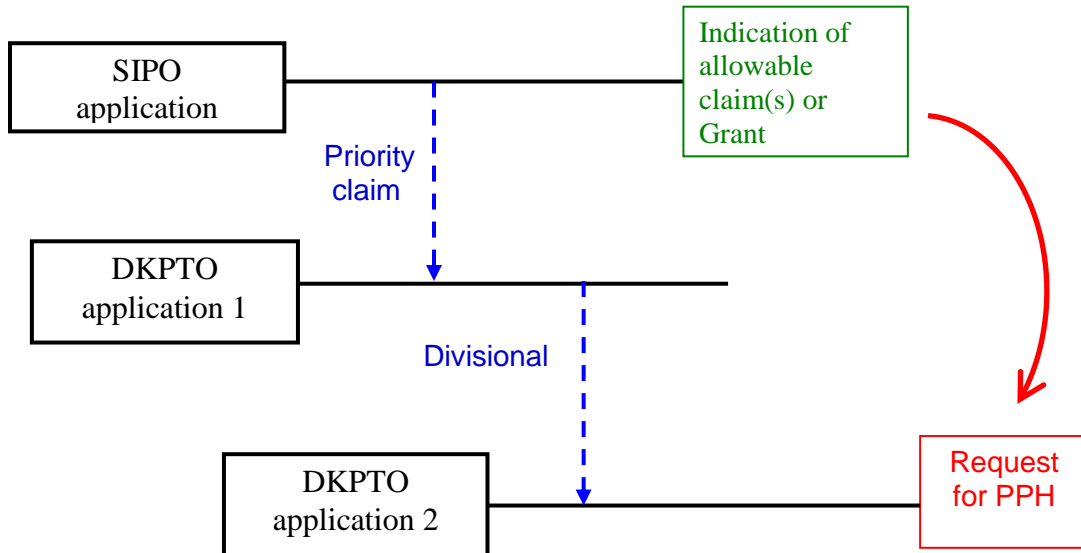

ANNEX II

PPH REQUEST

Request for Accelerated Examination at the DKPTO under the Patent Prosecution Highway Pilot Program between the DKPTO and SIPO

- 1** DK application number:
Corresponding SIPO application number(s):
- 2** **Either:**
a) Copy of SIPO office action(s) in English or a translation thereof in English or Danish attached:
or
b) SIPO office action(s) on file from previous PPH request:
DK application number:
- 3** **Either:**
a) Copy of claims of corresponding SIPO application in English or a translation thereof in English or Danish attached
or
b) SIPO application claims on file from previous PPH request:
DK application number:
- 4** Claim correspondence table attached:

Please ensure that this is the uppermost document when requesting accelerated examination under the PPH.

ANNEX III

The following figure contains examples of claims which meet the requirement of “sufficient correspondence” as laid down in PPH requirement c):

SIPO claims	Subject matter	DKPTO claims	Subject matter	Comment
1(independent)	A	1	A	The same as SIPO claim 1.
2(dependent on 1)	A + a	2	A + a + b	Claim 2 has the additional technical feature “b” on the SIPO claim 2.
3(dependent on 1)	A + b	3	A	Similar to SIPO claim 1 except for claim format.
		4	A + d (new independent claim)	Claim 4 has an additional technical feature “d” on the SIPO claim 1. Where "d" is supported in the description but is not claimed in the SIPO.

Where “A” is the subject matter and “a”, “b”, and “d” are the additional technical features which narrow (further restrict) the scope of the subject matter.

ANNEX IV**Claim Correspondence Table:**

DKPTO application claims	Corresponding claims allowed by SIPO	Explanation regarding the correspondence

Example of Completed Claim Correspondence Table:

DKPTO application claim	Corresponding claims allowed by SIPO	Explanation regarding the correspondence
1 to 5	1 to 5	Applicant has amended the claims to the present claims having the same scope as the claims of the applicant's corresponding SIPO application. SIPO claims 1 to 5 have been indicated as allowable in the SIPO Granted Patent _____, dated ____ .
1 to 3	1 to 3	Applicant has amended the claims to the present claims having the same scope as the claims of the applicant's corresponding SIPO application. SIPO claims 1 to 3 have been indicated as allowable.